

Full Module Door Station

2-Wire DT821

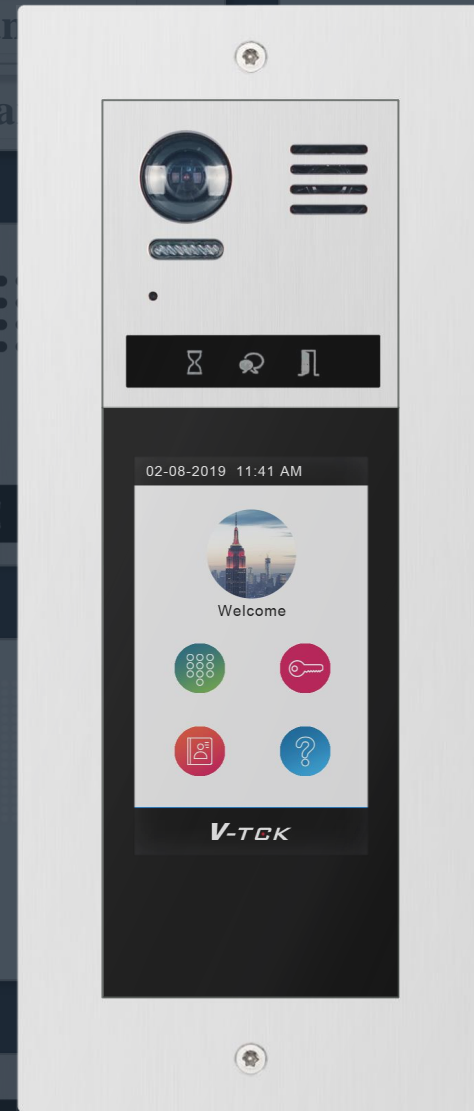

DT821

RFID/Pin code access
TFT Screen/Digital tube Display
Information board



Modularization

Voice prompt
Language customization



Voice Prompt



Easy Configure

Modularize fixing
Plug and play

IP54 water proof



Water-Proof



Stainless steel

304 Stainless Steel with
fingerprint-proof

Main Module

Essential Module

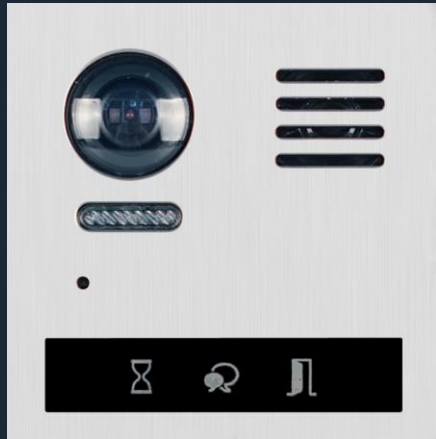

821-VD

170° Fisheye Camera

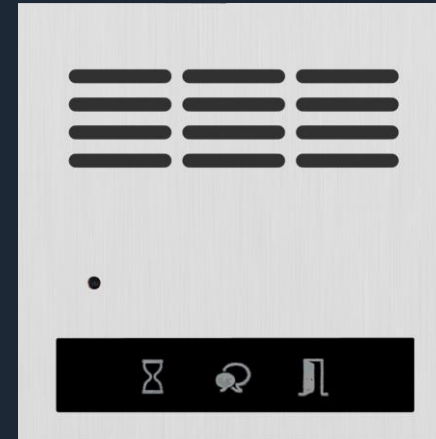

821-AD

Audio Only

Call Module

Calling modules

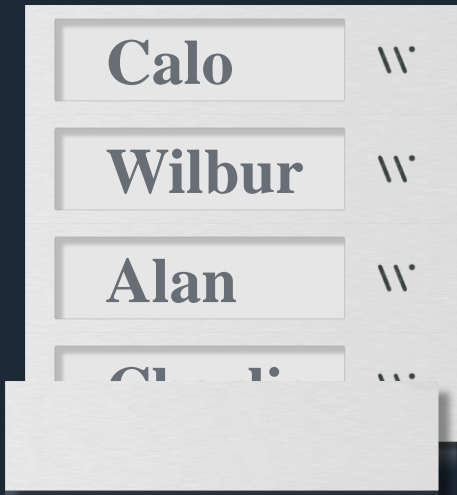

821-S4

- Metal touch calling button.
- Call button with name plate
- Name quick change by suction cup
- Optional blind cover (821-S0)

NEW!

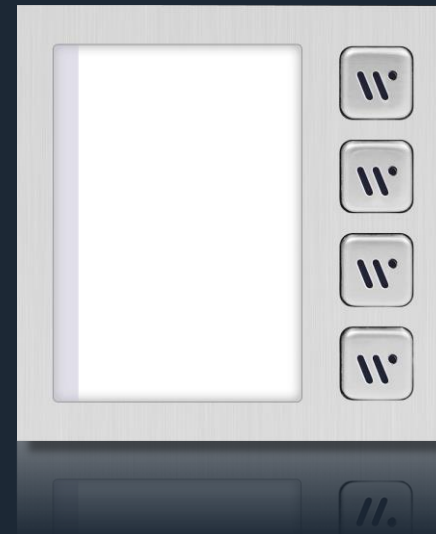

821-M4

- Mechanical calling button
- Fast change magnetic nameplate

Access Module

Access control module

NEW!



821-MK

- Password unlock
- Up to 20 sets passwords
- Mechanical Keypad
- Call to monitor



821-FP

- Fingerprint unlock
- Up to 200 fingerprints
- Semiconductor sensor

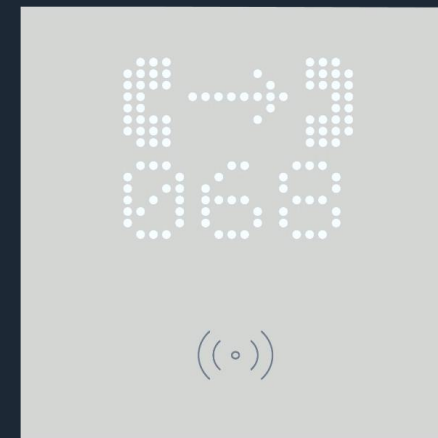

821-DR

- Card unlock
- Dot-Matrix display
- 125KHz & 13.56MHz Dual Standard
- *Plexi-glass surface
- *Dark-brown optional

Information Module

Display information module



821-TFT

TFT Screen
Namelist
Logo/Info Display

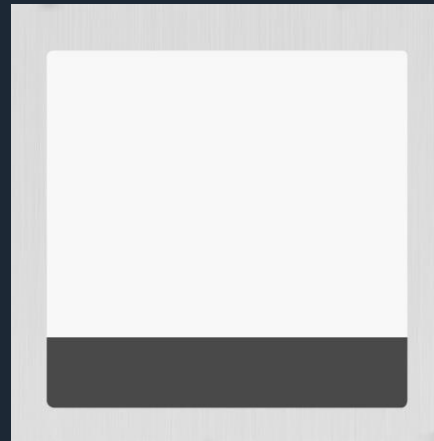

821-LB

Information Board with backlight

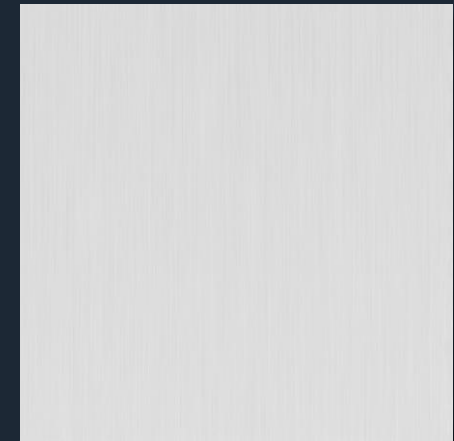

821-BL

Blank stainless steel
*Customizable laser printing text/logo/info

Integrated Module

Multi function module

5 Inch TFT touch screen

Full glass surface

Access card with both
12.5Khz and 13.65Mhz

Password unlock

Customizable menu

NEW!
821-T5

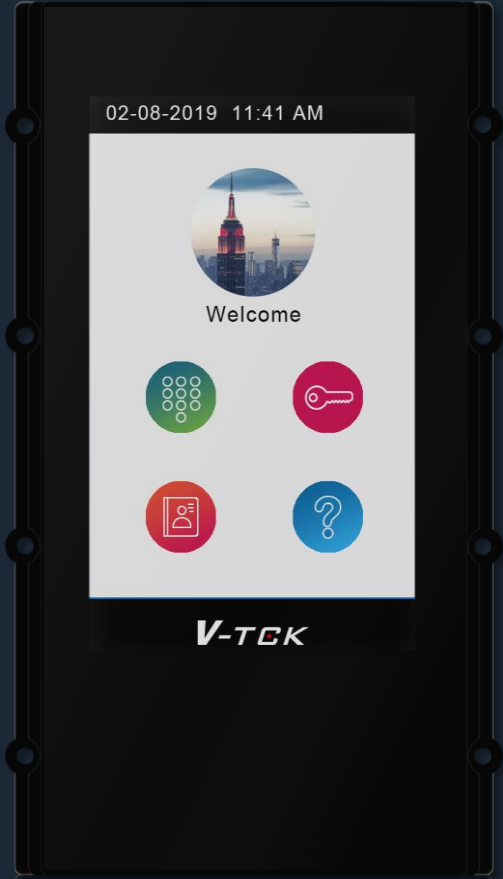

Frame & Mount Box

Flush or Surface



821 3x1-F

Flush Mount

Plastic in-wall mount box

*2x1 box is iron

Stainless steel Frame



821 3x1-S

Surface Mount

Aluminum built-in rain cover

Stainless steel box

Stainless steel Frame

2-Gang is available

Frame & Mount Box

Flush or Surface

821F-3X2

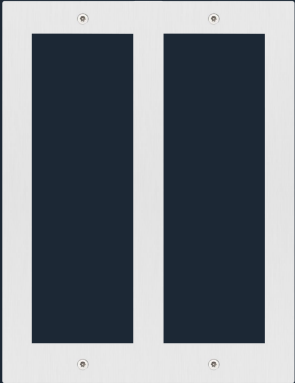

821F-3X1



821F-2X2

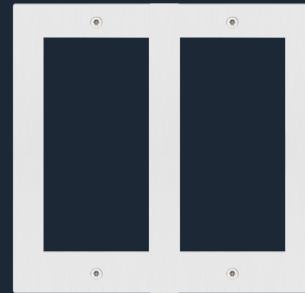

821F-2X1



821S-3X2



821S-3X1

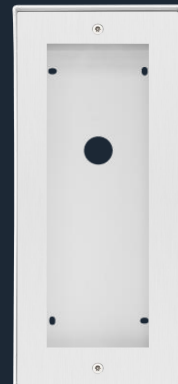

821S-2X2

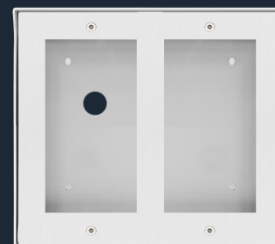

821S-2X1



Easy connection

Wiring easily

For Module:
821-TFT
821-LB
Using special ports.

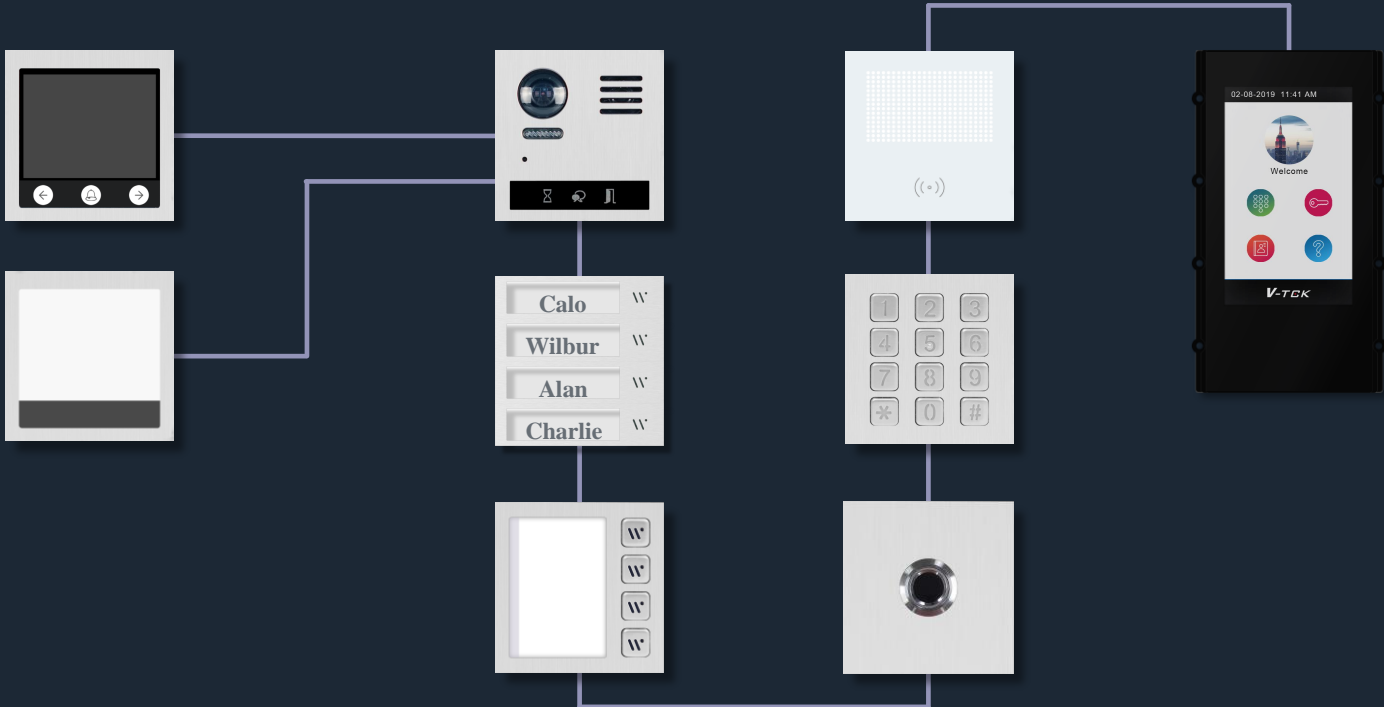

For Module:
821-S4
821-M4
821-DR
821-MK
821-FP
821-T5
One cable in-out for all.

Customizable laser print

On frame or module surface

Available 3 print styles for laser print



S211 Hollow

S212 Solid white

S214 Solid dark brown

Setup your DT821

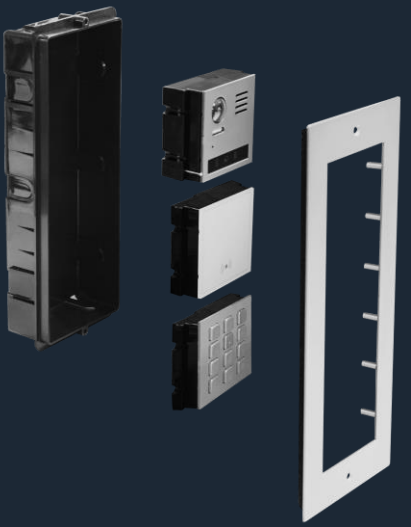

Main

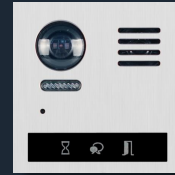

821-VD



821-AD

Integrated



821-T5

Call

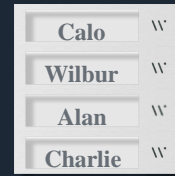

821-S4



821-M4

Access

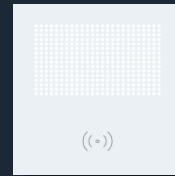

821-DR



821-MK

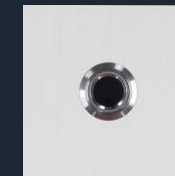

821-FP

Info



821-TFT

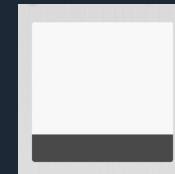

821-MK

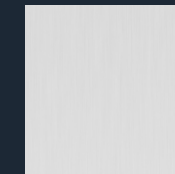

821-BL

Assembled

Finished product for order



DT821/DK-F

Video with
Dot-Screen Card Unlock
4 Buttons



DT821/BS4-F

Video with
4 Buttons

Dimension

Surface Mount

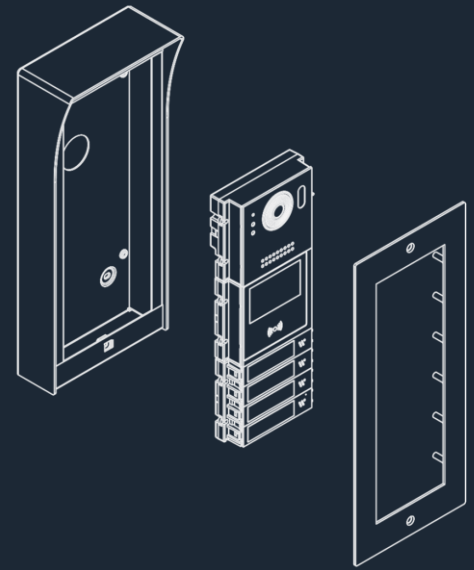
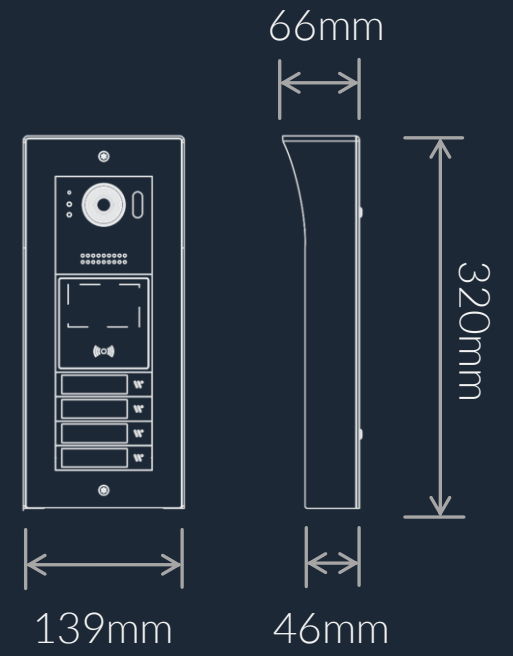

Flush Mount

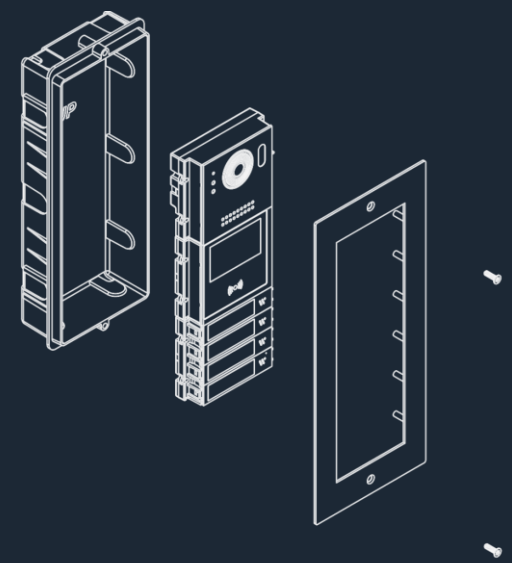
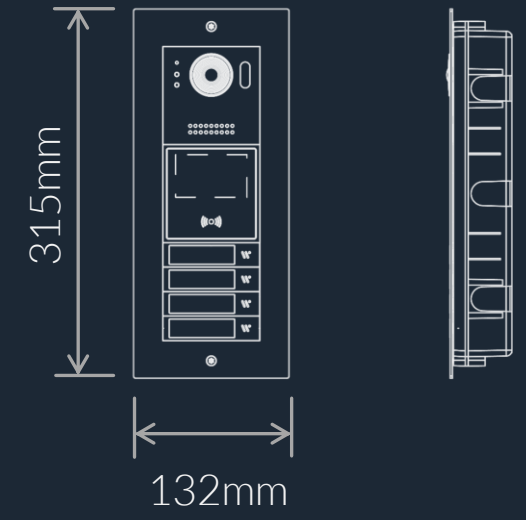

The logo for V-TEC is displayed in a bold, blue, sans-serif font. The letter 'V' is the largest and most prominent. The letter 'E' is stylized with a red diamond shape inside its upper loop. The letters 'T', 'C', and 'K' are also in blue and follow the same bold, sans-serif style. The logo is centered horizontally in the upper half of the image.

V-TEC

A Professional 2-wire Video Intercom Supplier

www.v-tec.com.cn
info@v-tec.com.cn